

1-800-BOLLARDS

The Bollard Experts

- SELECT DESIRED MATERIAL:
(6" NOMINAL SIZE)
- BSS06000 SCH 10 STAINLESS STEEL
 - BSS06040 SCH 40 STAINLESS STEEL
 - BSS06080 SCH 80 STAINLESS STEEL
 - BCS06040 SCH 40 ASTM A-53 CARBON STEEL
 - BCS06080 SCH 80 ASTM A-53 CARBON STEEL

- SELECT DESIRED STAINLESS STEEL BOLLARD FINISH:
- POLISHED #4 FINISH
 - AS SPECIFIED _____

- SELECT DESIRED CARBON STEEL BOLLARD FINISH:
- POWDERCOAT RAL # _____
 - AS SPECIFIED _____

- SELECT DESIRED STAINLESS STEEL BOLLARD MATERIAL:
- TYPE 304
 - TYPE 316

- SELECT DESIRED BOLLARD CAP STYLE:

-  DOME (SHOWN)
-  STANDARD FLAT
-  SLOPED

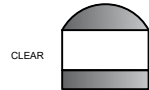

- LENS SELECTION

- CLEAR
- FROSTED
- INTERNAL FROSTED

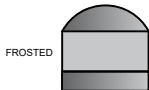

- PARACLINE SILVER
- PARACLINE WHITE

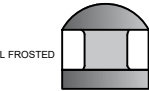

- LOUVER GREY
- LOUVER WHITE

- WATTAGE

- 5W 16LEDS 100mA
- 8W 16LEDS 175mA
- 12W 16LEDS 250mA



- CCT

- COOL
- NEUTRAL
- WARM

- VOLTAGE
- 120-277VAC
 - 120V

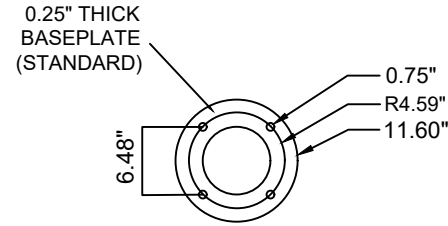
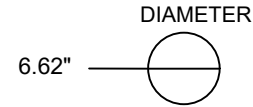
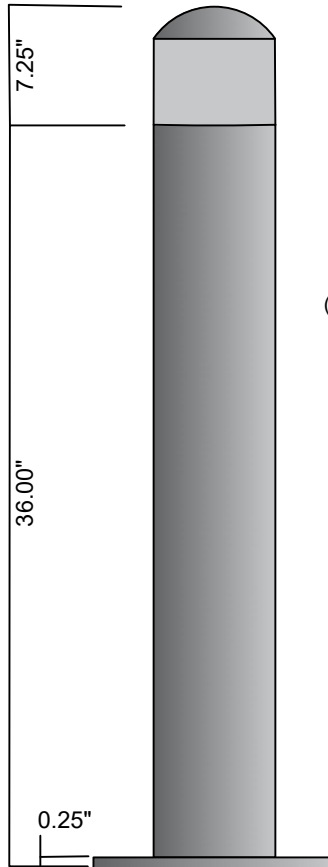
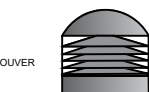

PLAN VIEW - BASE PLATE
(USED ON STAINLESS STEEL BOLLARD)

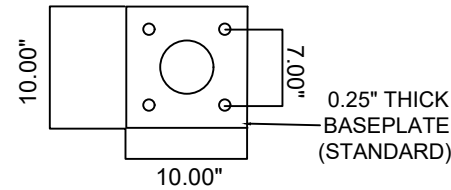

PLAN VIEW - BASE PLATE
(USED ON CARBON STEEL BOLLARD)

| REVISIONS | | | |
|---------------------------------|-------------|------|-------|
| LTR | DESCRIPTION | DATE | APPVD |
| | | | |
| | | | |
| | | | |
| | | | |
| | | | |
| | | | |
| | | | |
| COMMENTS | | | |
| | | | |
| | | | |
| | | | |
| | | | |
| | | | |
| | | | |
| | | | |
| SPECIFICATIONS | | | |
| HEIGHT: 36" | | | |
| DIAMETER: 6.62" | | | |
| WALL THICKNESS: 0.280" SCHED 40 | | | |

ALTERNATE INSTALL METHOD

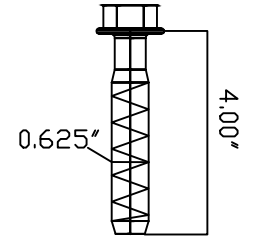

BASE PLATE REQUIRES
(4) 0.625"X 4" ANCHOR BOLTS
OR CINCH ANCHORS
BY OTHERS

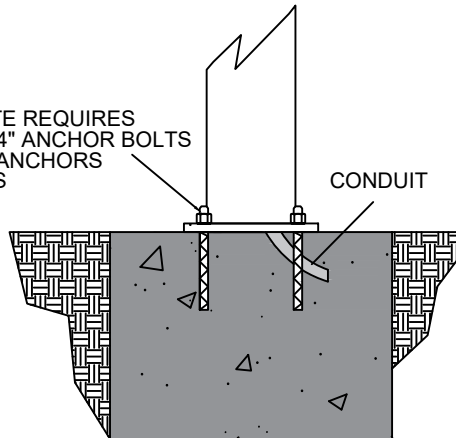

END VIEW - FOUNDATION

DOME (SHOWN) STANDARD FLAT SLOPED



| | | | |
|-----------------------------------------------------------------------------------------------------------------------------------------------------------------------------------------------|--------------------------|--------------|------------------------------------------|
| SERIES NUMBER: YX-S060-XX | CAGE CODE: 6NGJ8 | REV: 6th | DRAWING NUMBER: 6th Cutsheet Size A - R1 |
| PRODUCT FAMILY: FIXED BOLLARD | DRAWN BY: AJA | CHECKED BY: | DRAWING REV: |
| PRODUCT CLASS: STANDARD OR CUSTOMER DEFINED | CHECKED BY: | CHECKED BY: | SHEET: 1 OF 1 |
| PRODUCT LINE: BOLLARD | APPROVED BY: | APPROVED BY: | RELEASE DATE: |
| PRODUCT SUB LINE: BASEPLATE | TITL: BOLLARD, BASEPLATE | | |
| APPLICATION NEXT ASSY USED ON 1-800-BOLLARDS, Inc. 10 Hughes Suite A105 Irvine, CA 92618 PHONE: 1-800-BOLLARDS WEB: www.1800BOLLARDS.COM EMAIL: info@1800BOLLARDS.COM | | | |

1. REFER TO THE FOLLOWING FOR MORE COMPLETE INFORMATION IN ACCORDANCE WITH MANUFACTURER'S SPECIFICATIONS:
 2. DO NOT SCALE DRAWINGS.
 3. THIS DRAWING IS INTENDED FOR USE BY ARCHITECTS, ENGINEERS, CONTRACTORS, CONSULTANTS AND DESIGN PROFESSIONALS FOR PLANNING PURPOSES ONLY. THIS DRAWING MAY NOT BE USED FOR CONSTRUCTION.
 4. ALL INFORMATION CONTAINED HEREIN WAS CURRENT AT THE TIME OF DEVELOPMENT BUT MUST BE REVIEWED AND APPROVED BY THE PRODUCT MANUFACTURER TO BE CONSIDERED ACCURATE.
 5. CONTRACTOR'S NOTE FOR PRODUCT AND COMPANY INFORMATION VISIT www.CADWALL.com/1800 AND ENTER REFERENCE NUMBER 50467.